

ab 05.01.2017  
from 05.01.2017  
à partir du 05.01.2017

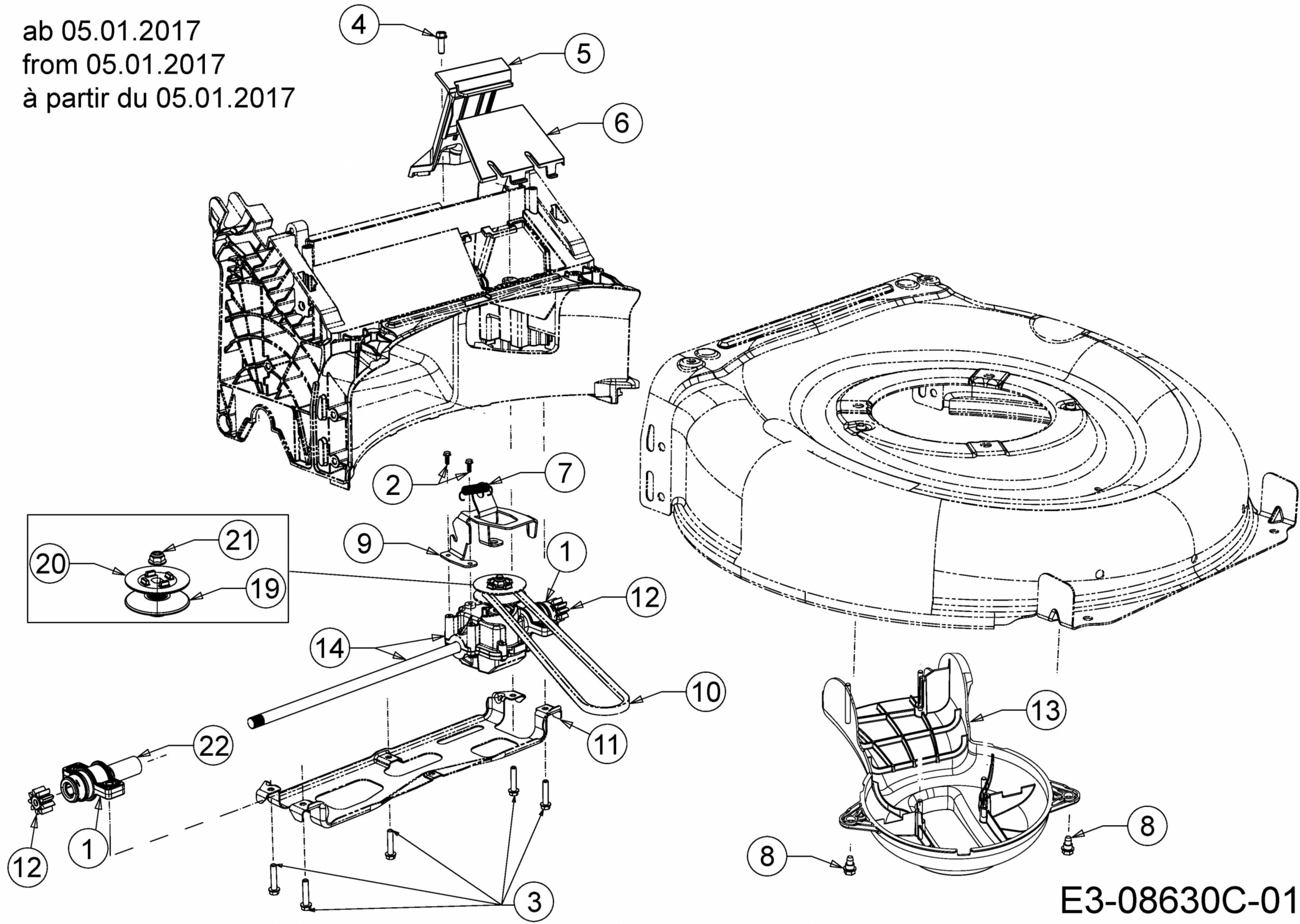

E3-08630C-01