

ab 17.12.2015
from 17.12.2015
à partir du 17.12.2015

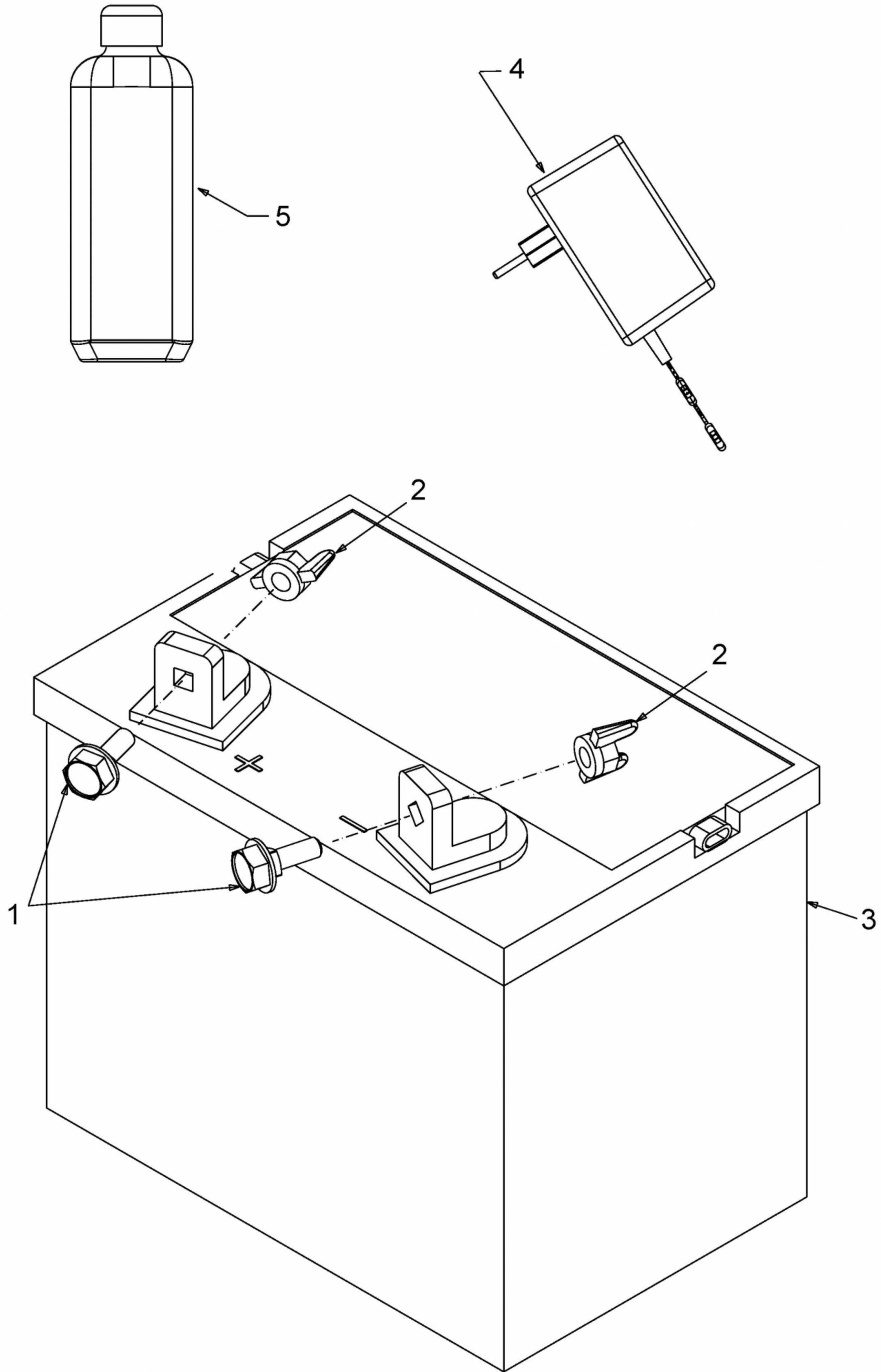

E3-06627A-02