

bis 30.04.2018
to 30.04.2018
jusqu'au 30.04.2018

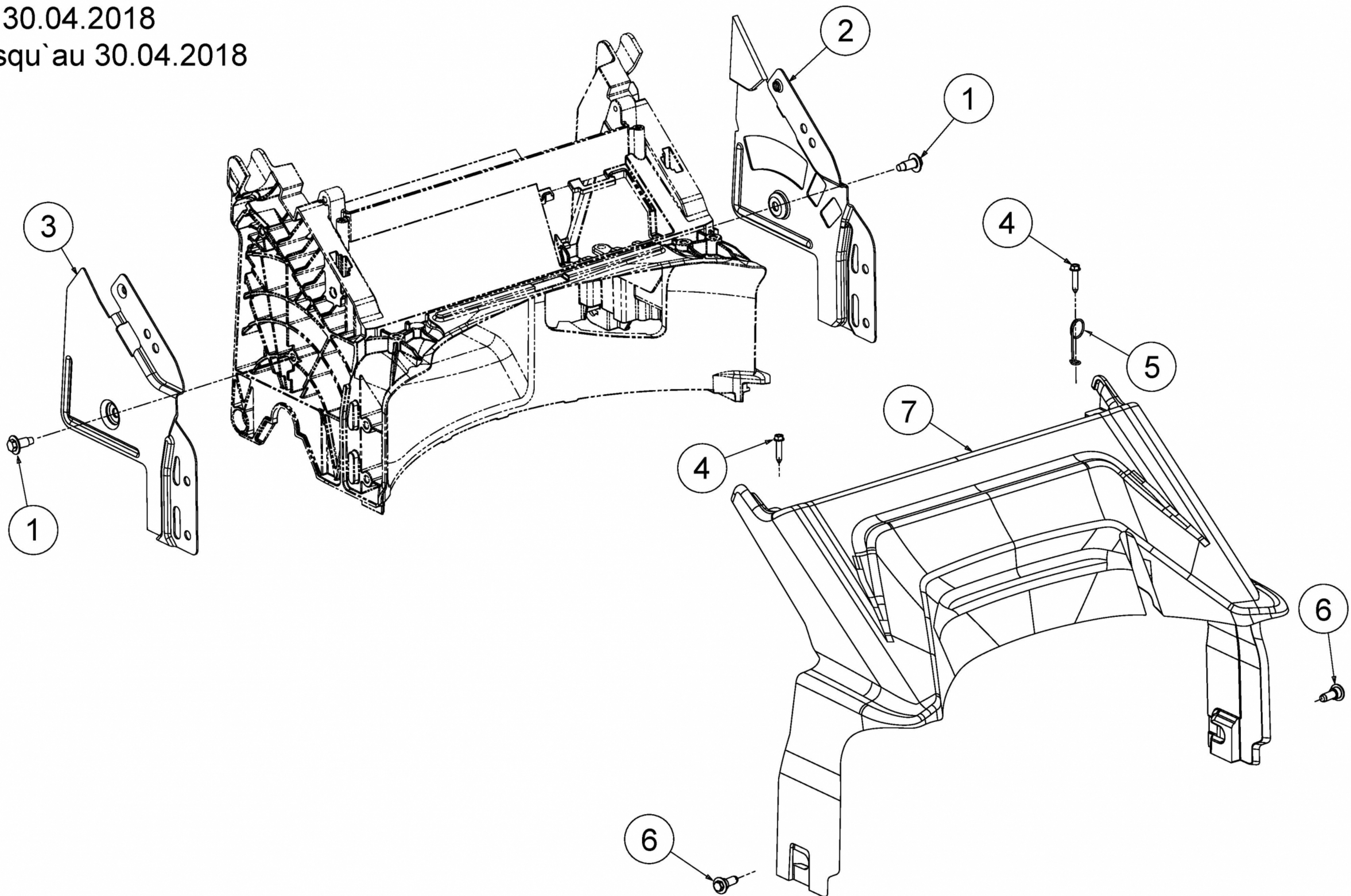

E3-03601D-01