

ab 01.05.2018
from 01.05.2018
à partir du 01.05.2018

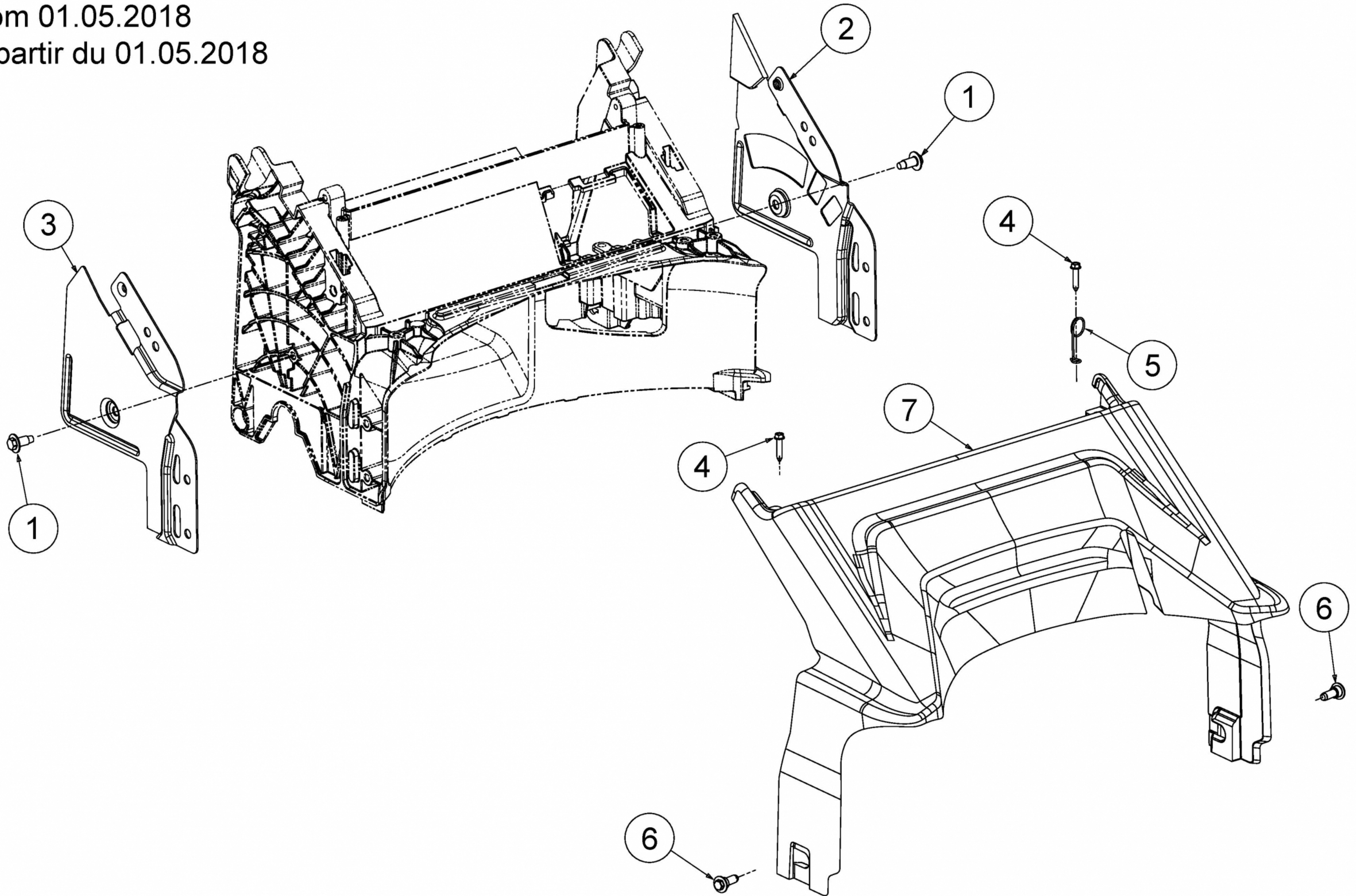

E3-00076A-01