

ab 20.11.2019
from 20.11.2019
à partir du 20.11.2019

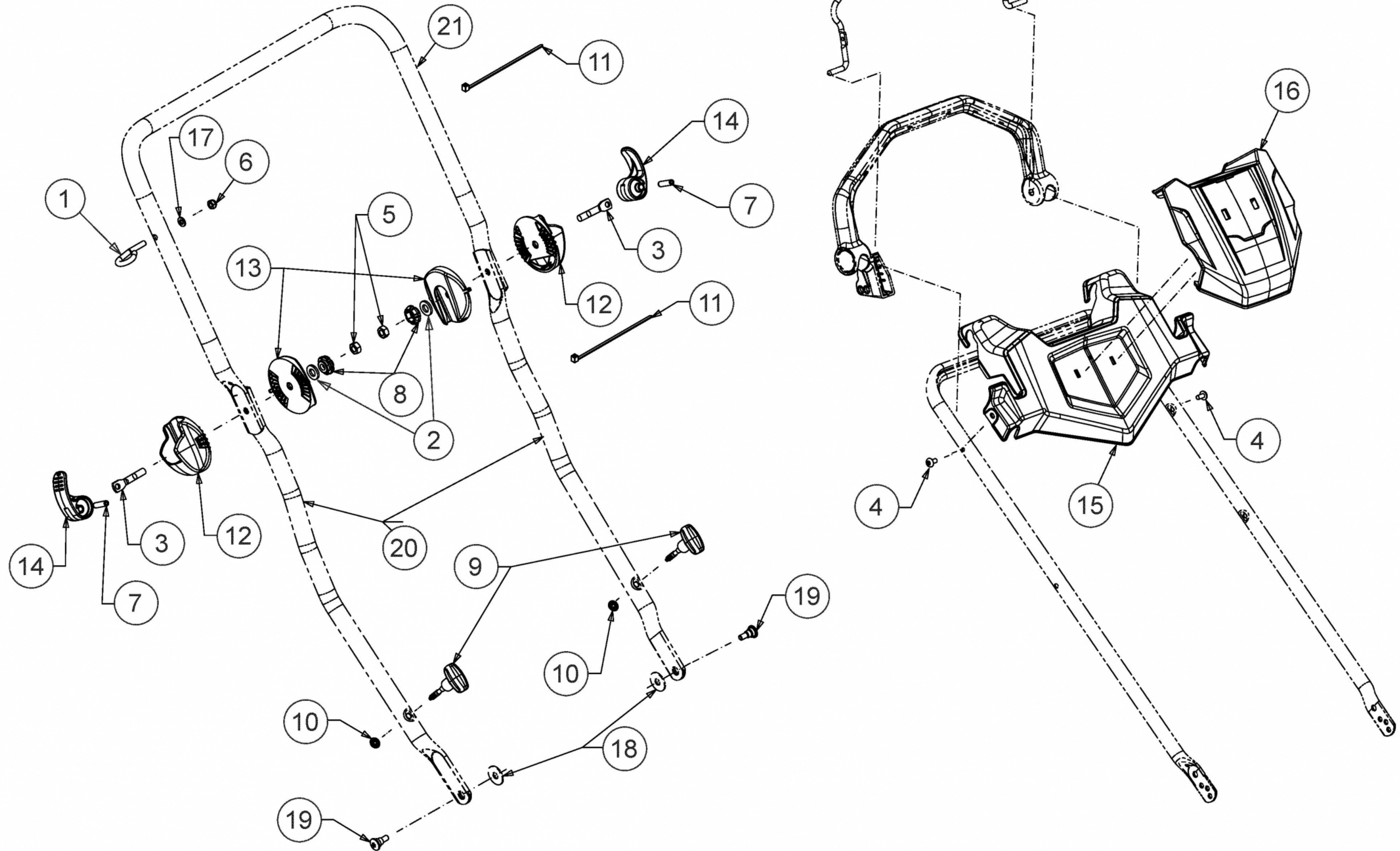

E3-00075B-02